

# VooDu marketing

[ NEXT GENERATION MULTICHANNEL MARKETING ]



Product Guide - March 2022

[voodumarketing.com.au](http://voodumarketing.com.au)



21	A-Frames
10	Aluminium Composite Panel (Dibond) Signs
3	Arch Banners
11	Backlit Poster Frames and Flat Panel Signs
7	Banner & Signage Stands
10	Bollard Covers (Corflute)
19	Bunting
13	Café Barriers
14	Café Umbrellas
16	Car Flags
16	Car Magnets
10	Corflute Signs
30	Crowd Barriers
13	Directional Signs
27	Exhibition Booths
17	Fence Mesh
14	Flag Pole Flags
11	Flat Panel Signs
23	Floor Stickers
23	Hand Sanitiser Dispensing Stations
15	Hand Wave Flags
30	Hanging Corflute Squares
32	Inflatables
31	Light Boxes
18	Marquees
24	Media Walls
12	Mesh Polyester Banners
16	Music Stand Covers
16	Pennants
26	Polyester Sleeve Floor Displays
20	Pop Up Banners
29	Promotion Tables
19	Pull Out Banners
5	Pull Up Banners
12	Retail Mesh Banners
30	Sampling Tables
15	Shop Front Flags
12	Smart Frames (Glassless)
13	Snap Lock Picture Frames
26	Stretch Fabric Arches
25	Stretch Fabric Displays
28	Table Covers
6	Table Top Banners
3	Tear Drop and Wing Banners
4	Tear Drop and Wing Banner Bases / Accessories
2	Tear Drop and Wing Banner Shapes / Sizes
17	Vinyl Banners
6	X-Banners

## Tear Drop Banner

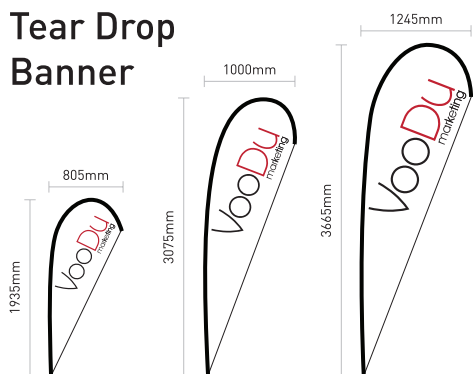

## Wing Banner Shape 1

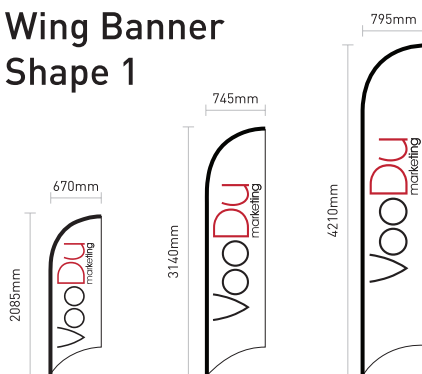

## Wing Banner Shape 2

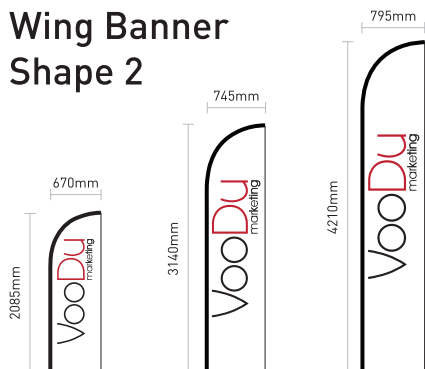

## Wing Banner Shape 3

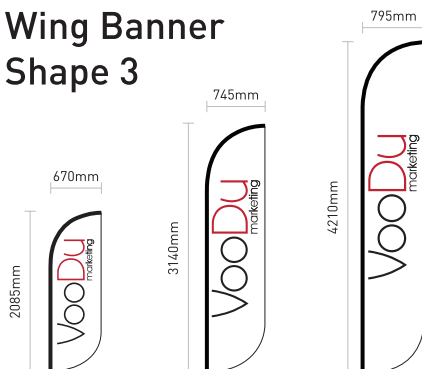

## Wing Banner Shape 4

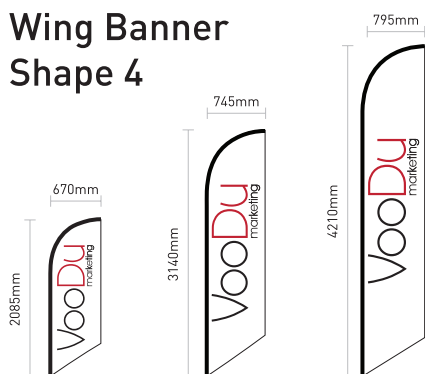

## Wing Banner Shape 5

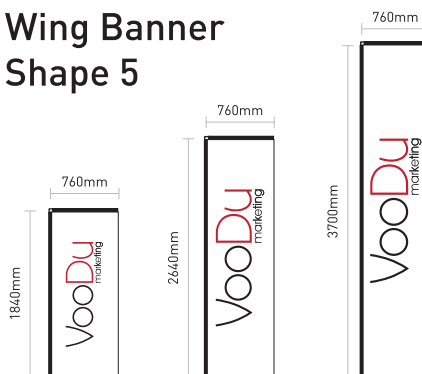

- Total set up height from ground dependent on pole size and base type
- Banners are supplied in an Oxford carry case and include pole kit and selected base type
- Banner sleeve pockets are black (or white if requested).





## Tear Drop and Wing Banners

### Supplied with base of choice

- Banner shapes and sizes are on page 2
- Banners are supplied with an Oxford carry case and base of choice
- Banner poles are fibreglass
- Banners are printed UV resistant full colour dye sublimation, banner sleeve pockets are black (or white if requested)
- Single sided banners are printed on 110gsm knitted polyester
- Double sided banners are printed on 2 pieces of 110gsm knitted polyester with a UV block-out sheet in-between to prevent the image on the other side of the banner showing through
- Standard lead time 10 - 15 days from artwork approval for orders up to 19 banners. Please contact us for lead time for orders of 20 or more banners

## Arch Banners

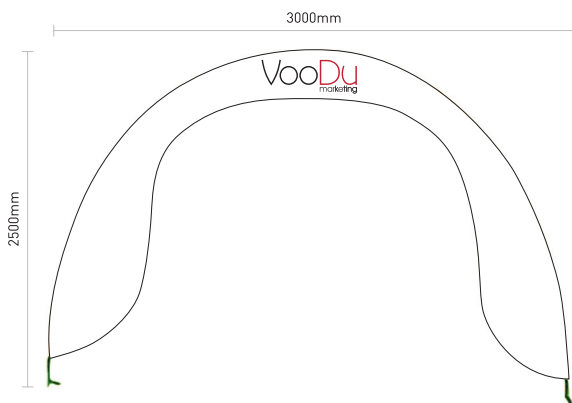

# Bases / Accessories



Water Bag  
(optional extra)

## Retractable Cross Base

- Weight - 3kg
- Chrome plated
- Great for installing wing and tear drop banners indoors or outdoors with a water bag



## Water Base

- Weight - approx. 18kg when filled
- Available in black only
- Perfect for installing wing and tear drop banners in windy areas



## Car Base

- Weight - 3kg
- Suitable for installing banners next to a vehicle as the car wheel holds the base in place



## Screw In Base / Spiky Base

- Light weight
- Excellent for installing wing and tear drop banners on lawn or other soft surfaces. Screw In Base can be left in ground permanently

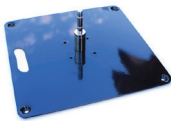

Water Bag  
(optional extra)

## Flat Metal Base

- Weight - 5kg
- Black powder coat with chrome spindle
- Great for installing wing and tear drop banners indoors or outdoors with a water bag



## Wall / Ground Mount Brackets

- Allows the banner to be installed off of the ground for increased height and visibility
- Available in 25 and 180 degree and ground mount bracket
- For use with SMALL and MEDIUM banners only

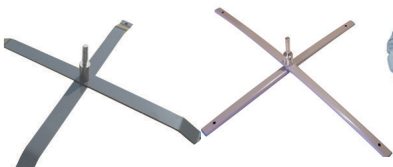

Water Bag  
(optional extra)

## Steel / Light Weight Swivel Base

- Steel - 4kg / Light Weight - 1.5kg
- Swivel feet for easy storage
- Great for installing outdoors with water bag or secure to ground with pegs (pegs not included)



## Marquee Water Base

- Weight - approx. 9kg when filled



## Marquee Weight

- Weighs 5kg

Diameter of spindle on all bases is 15mm

# Pull Up Banners

- Ideal for trade shows, showrooms, reception areas, displays, conferences, presentations etc.
- Quick set up and compact storage
- Budget Pull Up Banner supplied with silver aluminium base with fold out feet and black plastic end and feet caps (approx. 2.5kg)
- Light Weight Pull Up Banner supplied with silver aluminium base with fold out feet (approx. 3kg)
- Premium Pull Up Banner supplied with streamline weighted base (approx. 6kg)
- Full colour digital print on curl resistant Rite-Flat blockout media
- Supplied with padded carry bag
- Standard lead time for quantities up to 4 is 2 – 3 days from artwork approval.  
Please contact us for lead time for orders of 5 or more banners



**Budget Pull Up Banner**



**Light Weight Pull Up Banner**

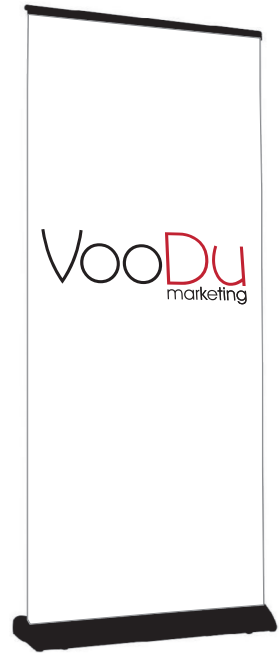

**Premium Pull Up Banner**

- Size options:
  - 600mm x 1600mm (available in Light Weight & Premium - single sided)
  - 850mm x 2000mm (available in Budget, single sided)
  - 850mm x 2100mm (available in Light Weight & Premium single sided or double sided)
  - 1000mm x 2100mm (available in Light Weight single sided & Premium single or double sided)
  - 1200mm x 2200mm (available in Light Weight single sided & Premium single or double sided)

## Table Top Pull Up Banners

- Silver aluminium light weight base available in A3 & A4
- Full colour single or double sided digital print on curl resistant polypropylene
- Ideal for trade shows, presentations, displays, conferences, etc.
- Standard lead time for quantities up to 4 is 2 – 3 days from artwork approval. Please contact us for lead time for orders of 5 or more banners



## Table Top Tear Drop Banners

- Full colour dye sublimation print on 110gsm knitted polyester
- 580mm tall, weight 0.3kg
- Single sided only (reverse image on back)
- Print can be different on each banner eg. different numbers for table settings
- Supplied with fibreglass pole and metal base
- Replacement skins available
- Standard lead time 10 - 15 days from artwork approval



## X-Banners

- Full colour digital print on matte polypropylene
- Print size 600mm x 1600mm
- Single sided only
- Supplied with light weight fibreglass frame and carry bag
- Standard lead time for quantities up to 4 is 2 – 3 days from artwork approval. Please contact us for lead time for orders of 5 or more banners





# Signage Stands

## Vinyl Banner Stands

- Ideal for trade shows, exhibitions, sporting events etc.
- Full colour digital print on 440gsm gloss vinyl or 360gsm vinyl mesh
- Suitable for single or double sided displays
- Quick set up and compact storage
- Light weight aluminium frame
- Frame size:
  - 2150mm x 1000mm
- Banner size:
  - 2000mm x 850mm
- Graphics are secured to the frame with elastic bungee style cords
- Packs flat for easy transportation
- Supplied with carry bag
- Standard lead time for quantities up to 4 is 2 – 3 days from artwork approval. Please contact us for lead time for orders of 5 or more



## Graphic Panel Stakes

- Suitable for soft ground outdoor surfaces
- Strong 5mm black powder coated wire frame with handle
- Quick set up and easy storage
- Corflute panel can be changed as required
- Available with single sided or double sided full colour print on SAV
- Size:
  - 600mm x 900mm (total height 1050mm)
- Standard lead time for quantities up to 4 is 3 - 5 days from artwork approval. Please contact us for lead time for orders of 5 or more

## Wire Stakes

- Strong 5mm wire to prevent stakes bending when inserting into the ground
- Corflute panel size: 600mm x 450mm
- Standard lead time for quantities up to 4 is 2 – 3 days from artwork approval. Please contact us for lead time for orders of 5 or more



## Breeze Panel Signs

- Great for shopping malls, pavements etc.
- Easy to assemble, light weight, no tools required
- Metal panel with black metal frame and plastic water fillable base for stability
- Full colour digital print on SAV
- Graphic size: 588mm x 917mm
- Tilt and move – wheels included
- Optional header board available
- Standard lead time 3 – 5 days from artwork approval



## Swing Spring Signs

- Great for trade shows, exhibitions, shopping malls, pavements etc.
- Easy to assemble, light weight, no tools required
- Plastic stand with water fillable base including wheels and moulded handle for easy movement
- 3mm corflute panels, both sides
- Full colour digital print on SAV
- Graphic size: 420mm x 600mm
- Standard lead time 3 – 5 days from artwork approval





## PVC Stands

- Full colour double sided digital print on SAV
- Stand size:
  - 500mm diameter
- Recommended panel size:
  - Corflute 460mm x 900mm
  - Aluminium Composite Panel (Dibond) 460mm x 1200mm
  - Custom sizes available
- Suitable for indoor or outdoor use
- Rounded corners & smooth edges on print panel minimise health & safety concerns
- Large visual area for maximum impact
- Rugged recycled PVC base for excellent stability
- Single nylon fixing - no tools required
- Base includes carry handle
- Standard lead time for quantities up to 4 is 3 - 5 days from artwork approval. Please contact us for lead time for orders of 5 or more



## Metal Stands

- Full colour double sided digital print on SAV
- Stand size:
  - 400mm x 300mm x 90mm
- Recommended panel size:
  - Corflute 450mm x 900mm
  - Aluminium Composite Panel (Dibond) 450mm x 1200mm
  - Custom sizes available
- Black powder coated metal stand holds a panel of up to 25mm thickness
- Suitable for indoor or outdoor use
- Rounded corners & smooth edges on print panel minimise health & safety concerns
- Large visual area for maximum impact
- Designed for use with a wide variety of substrates
- Standard lead time for quantities up to 4 is 3 - 5 days from artwork approval. Please contact us for lead time for orders of 5 or more

# Aluminium Composite Panel (Dibond) Signs

- Very durable - 3mm thickness
- Full colour SAV digital print with laminate for extra durability, single or double sided
- Suitable for indoor or outdoor use
- Custom sizes available
- Standard lead time for quantities up to 4 is 2 – 3 days from artwork approval. Please contact us for lead time for orders of 5 or more



# Corflute Signs

- 3mm or 5mm thickness
- Full colour SAV digital print, single or double sided
- Suitable for indoor or outdoor use
- Custom sizes available
- Standard lead time for quantities up to 4 is 2 – 3 days from artwork approval. Please contact us for lead time for orders of 5 or more



# Bollard Covers (Corflute)

- Full colour digital print on SAV
- Bollard cover size 270mm x 1000mm x 3mm corflute
- Standard lead time for quantities up to 4 is 2 – 3 days from artwork approval. Please contact us for lead time for orders of 5 or more



# Flat Panel Signs



- Ideal for a variety of outdoor uses
- Powder coated 50mm square steel tube frame available in black or white
- Aluminium Composite Panels (Dibond) used for the print area
- Full colour single or double sided print on SAV with laminate for added durability
- Large visual area for maximum impact
- Very easy to install – quick installation with star droppers (not included)
- Sizes:
  - 600mm x 900mm (total height 1500mm)
  - 900mm x 1200mm (total height 1800mm)
  - 1200mm x 1800mm (total height 2000mm)

# Backlit Poster Frames



- Great for trade shows, presentations, displays, shop windows, shopping malls etc.
- Full colour digital print on 200gsm backlit film
- Portrait or landscape orientation options
- Detachable and adjustable legs (**A4 and A3 sizes only**)
- Acrylic front - clear
- Light weight unit, 10mm thick (12mm for A1 size)
- Size options:
  - A4 (0.6kg)
  - A3 (1.0kg)
  - A2 (1.9kg)
  - A1 (4.2kg)
- Supplied with transformer
- Standard lead time for quantities up to 4 is 3 - 5 days from artwork approval. Please contact us for lead time for orders of 5 or more

# Mesh Polyester Banners

- Full colour dye sublimation print
- 130gsm polyester mesh fabric
- Banners are supplied with reinforced edges and eyelets every 1000mm
- Standard lead time 10 - 15 days from artwork approval



Any Size  
Banner  
Available

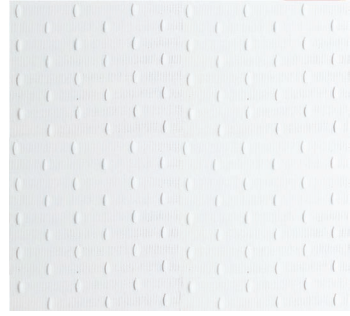

# Retail Mesh Banners

- Single sided or double sided print available
- Full colour dye sublimation on 100D polyester (other fabrics available)
- Supplied with aluminium snap lock frame with hooks top and bottom
- Any size available (up to 1500mm wide if aluminium snap lock frame required)
- Standard lead time 10 - 15 days from artwork approval



# Smart Frames (Glassless)

- Minimum order - 2 units
- Size options:
  - A3
  - A4
  - 89mm x 127mm
  - 127mm x 177mm
  - Print size is only governed by the width of the frame - the length can be any size
- Supplied with full colour digital print (can supply frame only)
- Light weight and easy to assemble
- Printing on frame available (on qty's of 100+ units)
- Huge variety of uses
- Replacement prints available
- Standard lead time for quantities up to 4 is 2 - 3 days from artwork approval. Please contact us for lead time for orders of 5 or more



A3 297 x 420mm
A4 210 x 297mm
127 x 177mm
89 x 127mm

# Directional Signs

- Suitable for interior use only
- Great for directional signage in shopping malls, exhibition halls, offices, airports etc.
- Hanging ceiling signs are double sided, can have 1 or 2 sign panels, include an anti-reflection cover and are supplied with a hanging kit
- Wall signs are single sided, include an anti-reflection cover and attach to the wall with double sided tape
- Various sizes available
- Standard lead time for quantities up to 4 is 3 - 5 days from artwork approval. Please contact us for lead time for orders of 5 or more

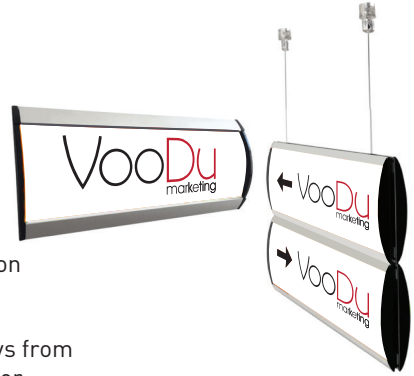

# Snap Lock Picture Frames

- Size options:
  - A4 print size
  - A3 print size
  - A2 print size
  - A1 print size
- 25mm rounded snap lock frame
- Supplied with full colour digital print (can supply frame only or print only)
- Replacement prints available
- Standard lead time for quantities up to 4 is 2 - 3 days from artwork approval. Please contact us for lead time for orders of 5 or more



# Café Barriers



- Great for use in café/restaurant alfresco areas or for other barrier uses
- Frame is supplied flat packed and simply clicks together
- Light weight aluminium tube frame with feet (43mm diameter frame)
- Full colour double sided dye sublimation on 230gsm polyester
- Size options:
  - 1040mm x 915mm (graphic area 900mm x 710mm, plus 65mm black outer sleeve)
  - 2040mm x 915mm (graphic area 1900mm x 710mm, plus 65mm black outer sleeve)
- Standard lead time 10 - 15 days from artwork approval

# Café Umbrellas

- Umbrella supplied with aluminium frame (47mm diameter pole) and printed canopy
- Canopy is 500D Oxford fabric which is waterproof, PU coated and flame retardant
- 2m x 2m canopy available with or without a valance
- Full colour dye sublimation
- Standard lead time 10 – 15 days from artwork approval



# Flag Pole Flags

- Flags include sister clips for easy installation - optional fittings available
- Flags are dye sublimated on 110gsm knitted polyester (approx. 90% bleed through) or 130gsm trilobal polyester (approx. 75% bleed through) with double stitched edges
- Standard sizes:
  - 1800mm x 900mm
  - 2500mm x 1250mm
  - Custom sizes available
- Double sided flags available
- 600D woven polyester available for extra durability and longer life
- Standard lead time 10 - 15 days from artwork approval for orders up to 49 flags. Please contact us for lead time for orders of 50 or more flags



Sister Clip



# Shop Front Flags

- Full colour digital print on 400gsm double sided vinyl or 500D double sided Oxford fabric
- Flag size 400mm x 600mm
- Supplied with removable plastic pole and 4 way bracket to allow set up at various angles
- Standard lead time 10 - 15 days from artwork approval

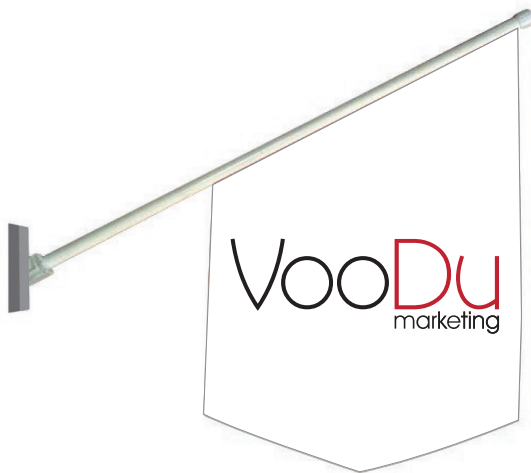

# Hand Wave Flags

- Standard flag size:
  - 300mm x 200mm
  - Custom sizes available
- Available in:
  - PVC : Double sided print on 0.2mm PVC
  - Polyester : Single sided print (100D polyester with approx. 85% bleed through)
  - Paper : Single or double sided print on coated paper
  - PPE Clear Plastic : Single sided print (with bleed through)
- Supplied with plastic pole
- Please contact us for lead times

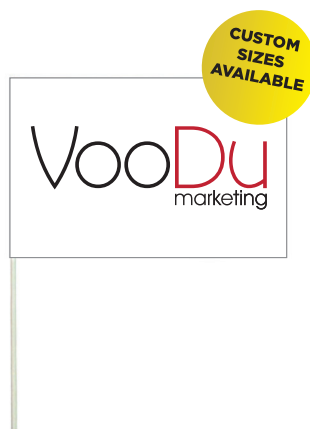

## Car Flags

- Flag size is 450mm x 300mm
- Full colour single sided digital print on 110gsm knitted polyester
- Supplied with plastic pole and car window clip
- Please contact us for lead times



## Car Magnets

- Full colour digital print on 0.9mm thick magnet
- Ideal signage for cars, vans, trucks etc.
- Recommended magnet size of 600mm x 300mm for best adhesion to vehicle
- Standard lead time for quantities up to 4 is 2 – 3 days from artwork approval. Please contact us for lead time for orders of 5 or more



## Music Stand Covers

- Standard size:
  - 540mm wide x 530mm high, plus 200mm sleeve to slide over music stand
  - Custom sizes available
- Full colour digital print on 160gsm satin drill
- Standard lead time 10 – 15 days from artwork approval



## Pennants

- Standard size:
  - 210mm x 300mm with 20mm tassels
  - Custom sizes available
- Full colour digital print on 160gsm satin drill
- Includes 360mm cord on 235mm wide pole
- Standard lead time 10 – 15 days from artwork approval



# Fence Mesh (Polyester or PVC)

- Full colour print
- Supplied with hemmed edges and eyelets
- Please contact us for lead times

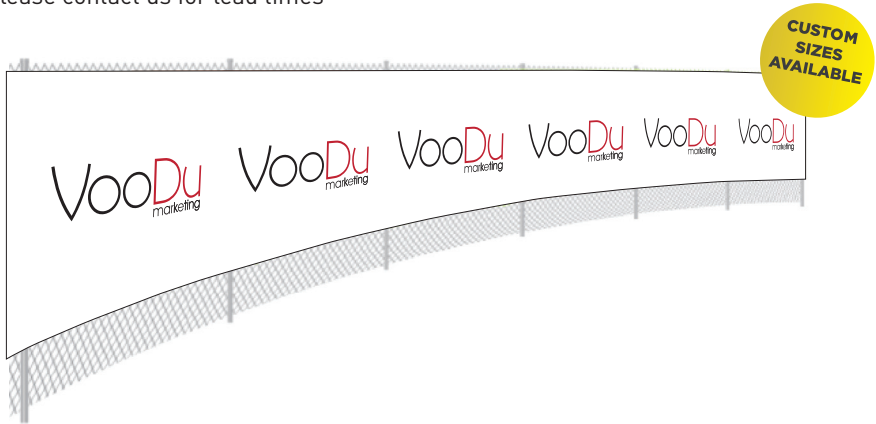

# Vinyl Mesh and Vinyl Banners

- Full colour CMYK digital print
- Single sided and double sided vinyl banners printed on outdoor quality vinyl (single sided only for vinyl mesh)
- Banners are supplied with welded edges and eyelets every 1000mm
- Standard lead time for quantities up to 4 (based on single sided and maximum height of 1500mm) is 2 – 3 days from artwork approval. Please contact us for lead time for orders of 5 or more banners, or banners that are double sided and/or larger than 1500mm along both height and width



# Marquees

- Supplied with 40mm aluminium frame, printed canopy, ropes, pegs and wheel bag
- Canopy is 500D Oxford fabric which is waterproof, PU coated and flame retardant
- Single sided or double sided full walls available for all sizes (half walls available for 3 metre sides only)
- Single sided walls available with window
- Clear protective screen walls available for 3 metre sides
- Full colour dye sublimation
- Size options:
  - 3m x 3m
  - 4.5m x 3m
  - 6m x 3m
- Replacement ropes and pegs available
- Frames and printed or unprinted walls and canopies available individually\*
- Sea freight available for orders of 10 + marquees
- Please contact us for lead times

## Marquee Extras

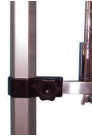

**Bracket for Wing / Tear Drop Banner**



**Gutter Kit**  
Gutter kit required when joining 2 marquees



**Sand Bag**



**Marquee Water Base**  
Weights approx. 9kg when filled



**Marquee Weight**  
Weights 5kg



\*Un-printed stock walls and canopies available in black, red, yellow, green and white

# Bunting

- Vinyl or polyester - single sided or double sided
- 30 flags per 10 metres as a standard - customisation available
- Standard sizes:
  - Triangle flags, 150mm x 200mm
  - Rectangle flags, 150mm x 200mm
  - Custom sizes available
- PVC also available - minimum order 2000 metres
- Please contact us for lead times

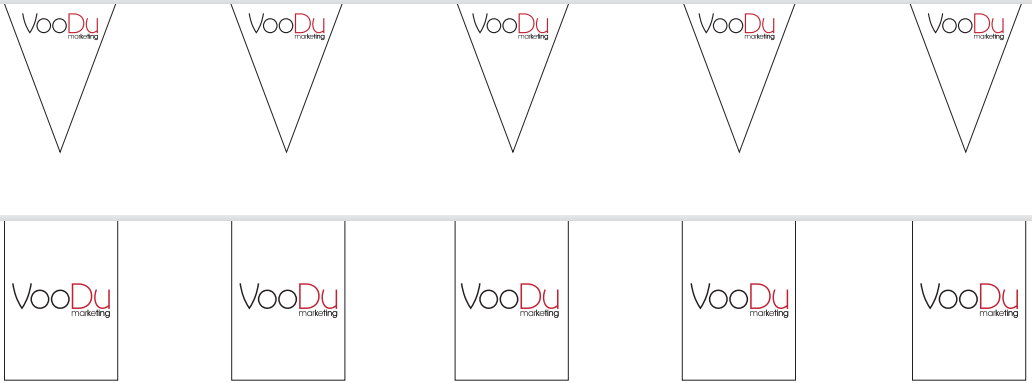
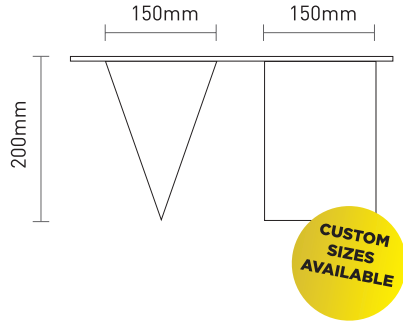

# Pull Out Banners

- Size of opened banner is 700mm x 240mm
- Double sided or single sided print available
- Offset gravure print
- Please contact us for lead times



# Pop Up Banners

## Round Pop Up Banners

- Full colour dye sublimation print on 240gsm knitted polyester
- Double sided
- Supplied with steel wire frame and carry case
- Size options:
  - 1200mm diameter
  - 1400mm diameter
- Standard lead time 10 - 15 days from artwork approval for orders up to 24 banners. Please contact us for lead time for orders of 25 or more banners



## Vertical Pop Up Banners

- Full colour dye sublimation print on 240gsm knitted polyester
- Double sided
- Target hole can be added
- Supplied with steel wire frame and carry case
- Size options:
  - 920mm x 1100mm
  - 1050mm x 1250mm
- Standard lead time 10 - 15 days from artwork approval for orders up to 24 banners. Please contact us for lead time for orders of 25 or more banners



## Horizontal Pop Up Banners

- Full colour dye sublimation print on 240gsm knitted polyester
- Double sided
- Supplied with steel wire frame and carry case
- Size options:
  - 1300mm x 660mm
  - 1600mm x 650mm
  - 2000mm x 1000mm
- Standard lead time 10 - 15 days from artwork approval for orders up to 24 banners. Please contact us for lead time for orders of 25 or more banners

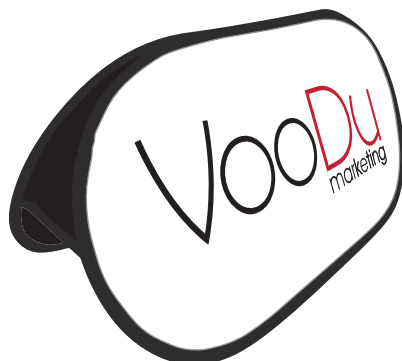

# A-Frames

## Light Weight Plastic A-Frames

- Takes panels up to 5mm thick
- Double sided full colour digital print (replacement prints available)
- Frame made from reinforced recycled fibreglass plastic
- Weight: Approx. 2.0kgs
- Panel size:
  - Up to 1000mm x 900mm
- Standard lead time for quantities up to 4 is 3 - 5 days from artwork approval. Please contact us for lead time for orders of 5 or more



## Premium Plastic A-Frames

- Unique hinge design - strong and robust
- User friendly handle
- Aerodynamic for best wind resistance
- 600mm x 450mm signage face
- Double sided
- Optional header clip and corflute header board available separately
- Weight: 5kg
- Standard lead time for quantities up to 4 is 3 - 5 days from artwork approval. Please contact us for lead time for orders of 5 or more



## Snap Lock A-Frames

- Aluminium Snap Lock frame
- Full colour digital print (replacement prints available)
- Print size 594mm x 841mm
- Double sided
- Standard lead time for quantities up to 4 is 2 - 3 days from artwork approval. Please contact us for lead time for orders of 5 or more



## Corflute Insert A-Frames

- Great for trade shows, presentations, shopping malls etc.
- 5mm corflute inserts, both sides
- Full colour digital print on SAV (replacement prints available)
- Metal frame
- Large visual area for maximum impact
- Sizes:
  - 600mm x 900mm (9.0kg)
  - 900mm x 1200mm (12.0kg)
  - 1200mm x 1800mm (16.5kg)
- Standard lead time for quantities up to 4 is 2 – 3 days from artwork approval. Please contact us for lead time for orders of 5 or more



## Metal A-Frames

- Great for trade shows, presentations, shopping malls etc.
- Metal frame with handle
- Metal panel on both sides
- Full colour digital print on SAV
- Large visual area for maximum impact
- Sizes:
  - 600mm x 450mm (6kg)
  - 600mm x 600mm (7kg)
  - 600mm x 900mm (9kg)
  - 900mm x 1200mm (12kg)
- Wheels available as an optional extra
- Standard lead time for quantities up to 4 is 2 – 3 days from artwork approval. Please contact us for lead time for orders of 5 or more

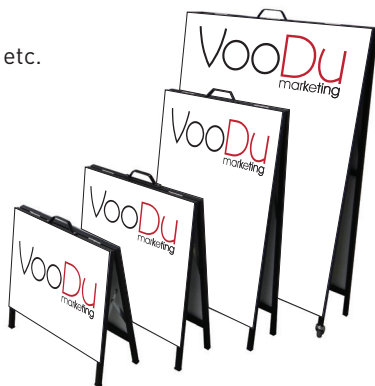

## Magnetic Chalk Board A-Frames

- Great for applications where the message needs to be changed regularly
- Solid beechwood timber frame
- Aluminium composite panel backing includes chalk board option with magnetic properties
- Double sided full colour digital print on SAV
- Sizes:
  - 590mm x 780mm
  - 600mm x 1200mm
- Standard lead time for quantities up to 4 is 2 – 3 days from artwork approval. Please contact us for lead time for orders of 5 or more





# Hand Sanitiser Dispensing Stations



- Full colour double sided digital print on SAV
- Black powder coated metal stand and Melamine board
- Suitable for indoor use
- Easy tool-free assembly
- Portable freestanding design, ideal for high-traffic areas
- Dispenser bottle capacity is 1000ml (sanitiser not included)
- Standard size:
  - Stand 400mm x 300mm x 90mm
  - Panel 450mm x 1200mm
- Weight is 8.5kg
- Battery powered (4 x 1.5v C size batteries included)
- Other hand sanitiser station styles available on request
- Standard lead time for quantities up to 4 is 2 – 3 days from artwork approval. Please contact us for lead time for orders of 5 or more

## Floor Stickers

- Floor stickers are a perfect advertising medium for floors, walls and footpaths
- Premium quality, offering long durability due to the composition of PVC and fabric
- Embossed textured matte finish to prevent slippage - R11 slip rating (Slip Resistance Test AS 4586:2031)
- Lifespan of the stickers is dependent on the movement at the place of installation, however, is estimated to be approximately 9 to 12 months in normal operation
- Full colour digital print and cut to custom sizes
- Stickers can be removed without leaving residue behind
- Standard lead time 3 – 5 days from artwork approval



CUSTOM  
SIZES  
AVAILABLE



# Media Walls

## Fixed Size Media Walls

- Great for trade shows, exhibitions, presentations, green screens, etc.
- Dye sublimation print on high quality 250gsm knitted polyester
- Wrap around printed sides available
- Graphics are attached to the aluminium concertina style frame with Velcro
- Size options:
  - 2250mm x 2250mm (flat or curved wall)
  - 3000mm x 2250mm (flat or curved wall)
- Set up and pull down in minutes
- Total weight of frame and print approx. 10kg
- Supplied with carry bag
- Sea freight available for orders of more than 20 units
- Standard lead time 10 - 15 days from artwork approval

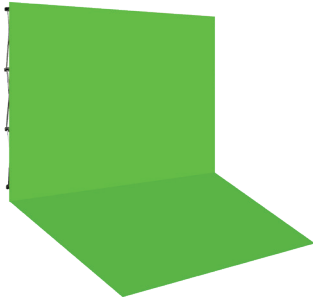

## Adjustable Media Walls

- Dye sublimation print on high quality 250gsm knitted polyester or full colour digital print on 440gsm vinyl
- Ideal for trade shows, exhibitions, presentations etc.
- Quick set up and compact storage
- Light weight telescopic frame
- Adjustable size options (knitted polyester):
  - Height: 1070mm - 2470mm
  - Width: 1470mm - 3150mm
- Adjustable size options (vinyl):
  - Height: 1070mm - 2470mm
  - Width: 1470mm - 1500mm (or to 3150mm if height is no more than 1500mm)
- Supplied with carry bag
- Standard lead time with polyester banner is 10 - 15 days from artwork approval. Standard lead time with vinyl banner is 2 - 3 days from artwork approval for quantities up to 4. Please contact us for lead times for orders of 5 or more



# Stretch Fabric Displays



Straight shape

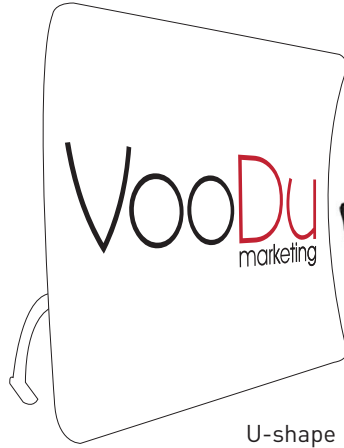

U-shape



\* All stretch displays supplied with carry bag



H-shape (flat, angled or curved top)



Snake shape

- Great for trade shows, presentations, displays, back drops etc.
- Light weight aluminium frame and feet (tube frame 1mm thick and 32mm diameter)
- Frame clicks together for quick and easy assembly and dismantle
- Full colour double sided dye sublimation print on 250gsm stretch polyester sleeve (Snake and U-shape displays available as single sided print only)
- Size and shape options:
  - Straight shape (2950mm x 2210mm or 5940mm x 2210mm)
  - H-shape (flat, angled or curved top, 1000mm x 2500mm)
  - U-shape (single sided print only 3000mm x 2280mm)
  - Snake shape (single sided print only 915mm x 2280mm)
- Supplied with carry bag
- Standard lead time 10 – 15 days from artwork approval

# Polyester Sleeve Floor Displays

- Great for trade shows, presentations, back drops etc.
- Light weight aluminium frame with plastic foldable feet (suitable for indoor use)
- Frame clicks together for quick and easy assembly and dismantle
- Full colour double sided polyester pillow case style sleeve
- Size options:
  - 850mm x 2000mm
  - 1000mm x 2300mm
  - 1200mm x 2300mm
  - 2400mm x 2300mm
  - 2950mm x 2300mm
- Supplied with carry bag
- Standard lead time is 10 – 15 days from artwork approval

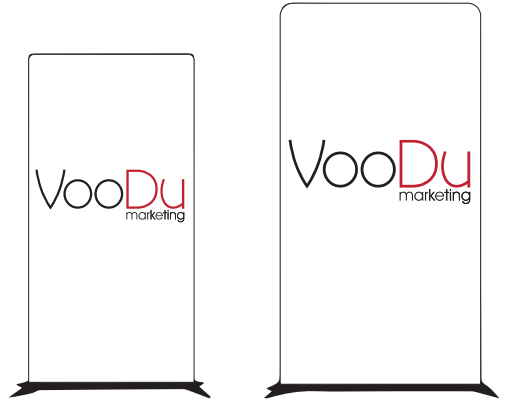

# Stretch Fabric Arches

- Great for trade shows and exhibitions
- Light weight aluminium frame simply clicks together for easy set up
- Full colour double sided dye sublimation on stretch fabric polyester
- Sizes:
  - 2970mm x 1000mm x 2300mm
  - 5200mm x 1000mm x 3000mm
- Supplied with carry bag
- Please contact us for lead time

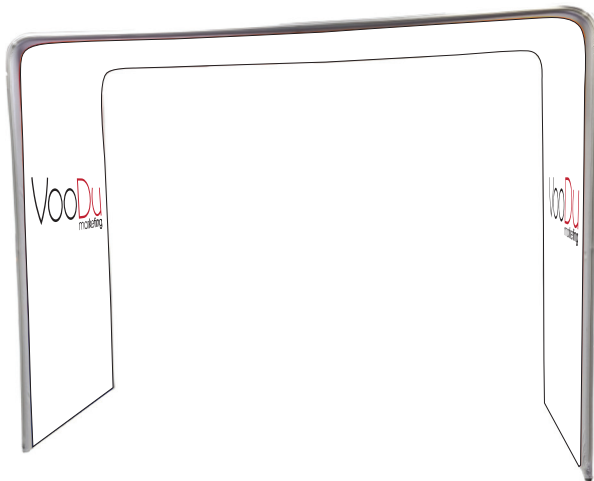

# Exhibition Booths

## Portable Trade Show Exhibition Booths

- Great for trade shows, presentations, product launches, back drops etc.
- Light weight aluminium frame and feet (tube frame 1mm thick and 32mm diameter)
- Frame clicks together for quick and easy assembly and dismantle
- Full colour double sided dye sublimation print on 240gsm stretch polyester sleeve
- Various size and shape options available
- Optional accessories available (LED lights, TV stand, S-connect joiner, leg inserts / joiners and table stand)
- Supplied with carry bag
- Standard lead time 10 – 15 days from artwork approval



Exhibition Booth A Includes:

- 1 x 3m stretch fabric display
- 1 x 1m stretch fabric display (flat, angled or curved top)
- 1 x 900mm x 400mm x 850mm promotional table
- 1 x leg connector



Exhibition Booth B Includes:

- 1 x 3m stretch fabric display
- 2 x 1m stretch fabric displays (flat, angled or curved top)
- 1 x 900mm x 400mm x 850mm promotional table
- 2 x leg connectors



Exhibition Booth C Includes:

- 2 x 3m stretch fabric displays
- 2 x 1m stretch fabric displays (flat, angled or curved top)
- 1 x 900mm x 400mm x 850mm promotional table
- 3 x leg connectors



Exhibition Booth D Includes:

- 1 x 6m stretch fabric display
- 2 x 1m stretch fabric displays (flat, angled or curved top)
- 1 x 900mm x 400mm x 850mm promotional table
- 2 x leg connectors

# Table Covers

## Drape or Fitted Table Covers

- Available in drape or fitted style with open or closed back and hemmed edges
- Full colour dye sublimation print on 250gsm knitted polyester
- Entire table cover can be printed
- Standard sizes:
  - 1800mm (6 Foot) table top - 1800mm x 700mm with 700mm fall (table cover total size 3200mm x 2100mm)
  - 2400mm (8 Foot) table top - 2400mm x 700mm with 700mm fall (table cover total size 3800mm x 2100mm)
  - Custom sizes available
- Standard lead time 10 - 15 days from artwork approval for orders up to 24 table covers. Please contact us for lead times for orders of 25 or more table covers



## Stretch Table Covers

- Full colour dye sublimation print on 200gsm stretch polyester fabric
- Entire table cover can be printed
- Available with an open back or closed back (with or without a zip)
- Size options:
  - 1200mm (4 foot) table top - 1230mm x 750mm with 610mm fall
  - 1800mm (6 foot) table top - 1820mm x 750mm with 720mm fall
  - 2400mm (8 foot) table top - 2410mm x 750mm with 720mm fall
- Standard lead time 10 - 15 days from artwork approval for orders up to 24 table covers. Please contact us for lead times for orders of 25 or more table covers



# Promotion Tables



## Exhibition Tables

- Great for trade shows, exhibitions, presentations etc.
- Full colour digital print on 415gsm PET film
- Quick set up and compact storage
- Black or wood look tabletop
- Light weight frame
- Rear opening to access storage shelf
- Size options:
  - 900mm x 400mm (table top) x 850mm (h), 13kg
  - 1300mm x 400mm (table top) x 890mm (h), 16kg
- Supplied with carry bag
- Standard lead time for quantities up to 4 is 2 – 3 days from artwork approval. Please contact us for lead time for orders of 5 or more

## Fabric Covered Tables

- Great for trade shows, exhibitions, presentations etc.
- Entire table cover can be printed
- Dye sublimation print on 250gsm knitted stretch fabric
- Includes light weight frame
- Table size:
  - 800mm x 500mm (table top) x 1000mm (h), 5kg
- Graphic size:
  - 2200mm x 1020mm
- Standard lead time 10 – 15 days from artwork approval



## Light Box Counters

- Great for trade shows, exhibitions, presentations etc.
- Easy to assemble light weight aluminium frame – no tools required
- Full colour double sided dye sublimation print on 150gsm polyester
- Bright LED lights used to ensure intense visual effect
- Size:
  - 1000mm x 1030mm
- Supplied with hard shell wheel bag
- Standard lead time is 10 – 15 days from artwork approval



## Sampling Tables

- Great for trade shows, exhibitions, presentations etc.
- Full colour digital print on 415gsm PET film
- Light weight, portable and compact storage
- Internal shelf & header board
- Quick and easy assembly - no tools required
- White finish plus print
- Size:
  - 750mm x 470mm (table top) x 800mm (h), 9kg
  - Height including header board, 2000mm
- Standard lead time for quantities up to 4 is 3 - 5 days from artwork approval. Please contact us for lead time for orders of 5 or more

## Crowd Barriers

- Great for trade shows, displays, shopping malls, event barriers etc.
- Stainless steel structure with 8kg bases
- Various graphic materials available - polyester, vinyl or vinyl mesh
- Graphic size:
  - 1930mm x 850mm
- Standard lead time with polyester banner is 10 - 15 days from artwork approval. Standard lead time with vinyl or vinyl mesh banner is 2 - 3 days from artwork approval for quantities up to 4. Please contact us for lead time for orders of 5 or more



## Hanging Corflute Squares

- Great for trade shows, presentations, product launches, displays, shopping malls etc.
- Full colour SAV print on corflute
- Size options:
  - Maximum size 1500mm (square) x 600mm high
  - Custom sizes available
- Large visual area for maximum impact
- Suitable for indoor use
- Standard lead time for quantities up to 4 is 2 - 3 days from artwork approval. Please contact us for lead time for orders of 5 or more



# Light Boxes

## Polyester Panel Insert Light Box

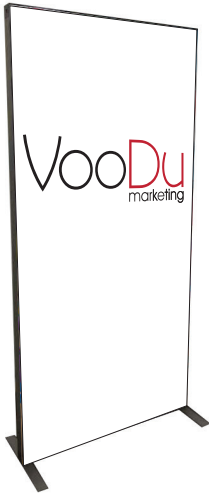

- Great for trade shows, presentations, displays, shop windows, shopping malls etc.
- Easy to assemble light weight aluminium frame
- Full colour single sided or double sided dye sublimation print on 150gsm polyester
- Bright LED lights used to ensure intense visual effect
- Size options:
  - 992mm x 1984mm
  - 1984 mm x 1984 mm
  - 2480mm x 1984mm
- Standard lead time 10 – 15 days from artwork approval

## Polyester Sleeve Light Box

- Great for trade shows, product displays, conferences etc.
- Light weight aluminium frame clicks together for easy assembly
- Full colour double sided dye sublimation on 250gsm polyester sleeve
- Bright LED lights used to ensure intense visual effect
- Size:
  - 900mm x 2300mm
- Standard lead time is 10 – 15 days from artwork approval



# Inflatables

- Full colour dye sublimation print
- Supplied with electric pump for inflation, ropes and pegs for installation and repair patches
- Please contact us for lead times

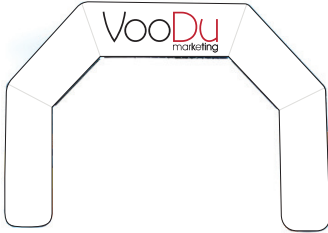

## Inflatable Arch

- Size options:
  - 3000mm x 2850mm
  - 5090mm x 3340mm
  - 7000mm x 5000mm

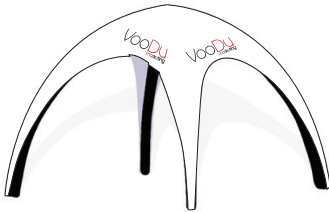

## Inflatable Tent

- Size options:
  - 10 foot: 3000mm x 2400mm
  - 13 foot: 4000mm x 3100mm
  - 16 foot: 5000mm x 3650mm
  - 20 foot: 6000mm x 4400mm

Air tent awnings and walls also available

## Inflatable Banner or Pillar

- Banner size options:
  - 6 metre
  - 8 metre
  - 10 metre
  
- Pillar size options:
  - 400mm x 2500mm
  - 670mm x 3000mm

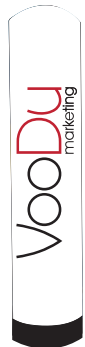



Ground Floor, 96 Pelham Street Carlton, Victoria Australia 3053  
+61 3 9077 4888  
info@VooDu.com.au  
www.voodumarketing.com.au